

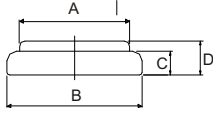

CR2330 Specification

Primary Lithium Manganese Dioxide Battery

Nominal Voltage	3V	 <p>A = $\phi 20.3$ B = $\phi 23.0^{+0.03}$ C = 2.4 D = $3.0^{+0.05}$</p> <p>Dimension: mm</p> 
Nominal Capacity	260mAh	
Continuous Standard Load	15K Ω	
Operating Temperature	-20° - 70°C	
Weight	4.0g	
Max. Continuous Discharge	0.75mA	
Max. Pulse Discharge	15mA	

Discharge Characteristics

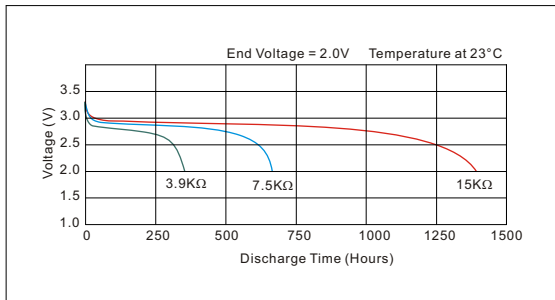

Temperature Characteristics

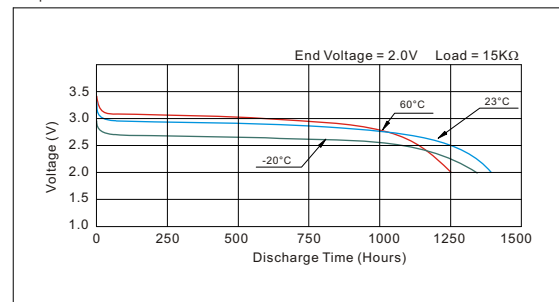

Load vs. Operating Voltage

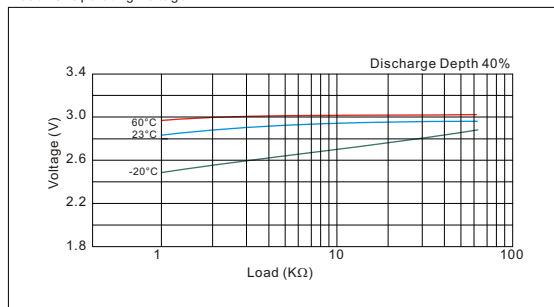

Load vs. Capacity

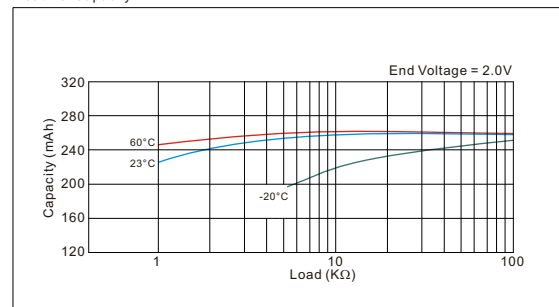

Pulse Discharge Characteristics

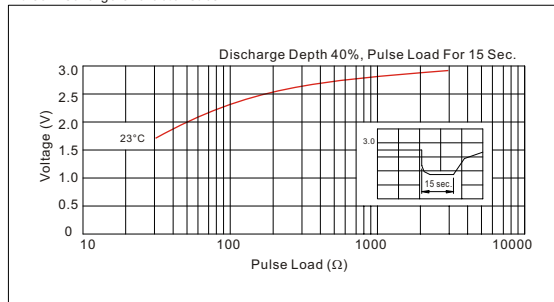

Storage Characteristics

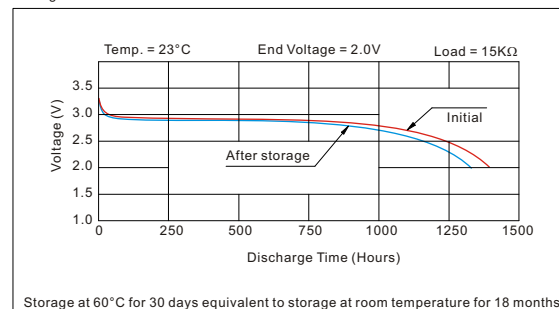

WARNING: Risk of fire and burn. Do not recharge, disassemble, heat above 100°C or incinerate. Do not mix fresh batteries with used batteries.

**Note: The data in this document are for descriptive purposes only and subject to change without prior notice.