

Typical Characteristics

Model: MHX-2000AA		
Specifications		
Nominal Voltage (V)		1.2V
Capacity	Typical (mAh)	2000
	Minimum (mAh)	1900
Dimension	Diameter (mm)	14.5 ⁺⁰ _{-0.7}
	Height (mm)	50.5 ⁺⁰ _{-1.5}
Charging	Standard	190mA x 16 hrs
	Rapid	950mA x 2.4 hrs - ΔV = 5mV
Operating Temperature (°C)	Standard Charging	0 ~ 40°C
	Rapid Charging	10 ~ 40°C
	Discharging	-10 ~ 55°C
	Storage	-20 ~ 30°C
Service Life	>500 cycles (IEC 16951-2 2003)	
Internal Resistance	30m Ohm / cell	
Weight	Approx.27g / cell	
Cuff-off Voltage (V)	1.00 V	

NiMH Cylindrical Battery Low Self-Discharge Version Size: AA IEC: KR15/51

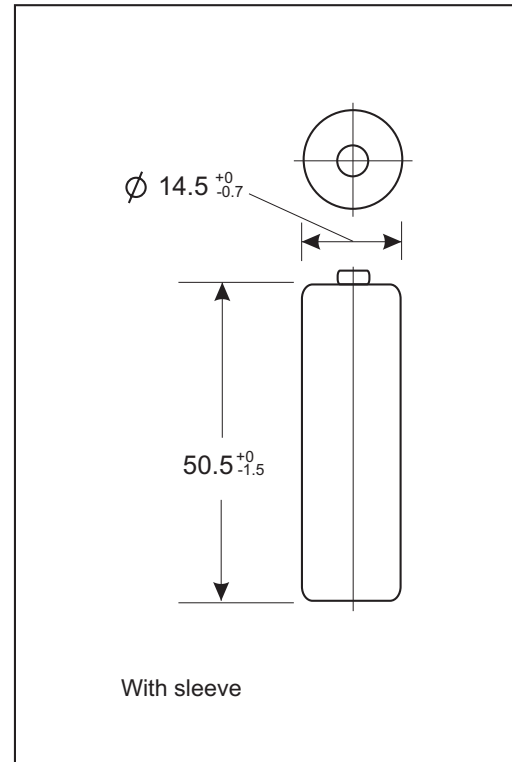

Charge (Capacity) Retention (at 20°C)

Charge	Storage	Discharge	Capacity Retention
190mA 16 hours	6 months	380mA to 1.0V	80%
190mA 16 hours	1 year	380mA to 1.0V	70%

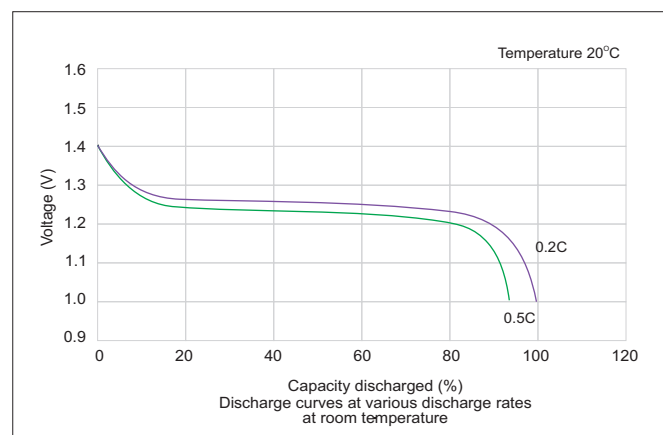
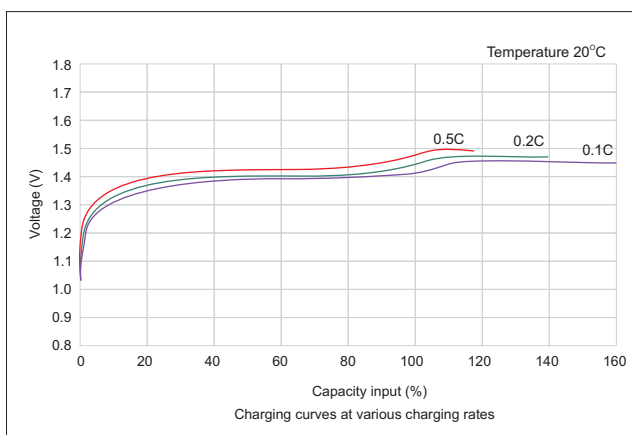

**Note: The data in this document are for descriptive purposes only and subject to change without prior notice.